

LOW TOP TOWER CRANE

RTT 330

16 HR23/HP20 II/IV/FALLS

TECHNICAL DATA SHEET

RTT 330



MORITSCH

CRANES SINCE 1962





MORITSCH

C R A N E S S I N C E 1 9 6 2

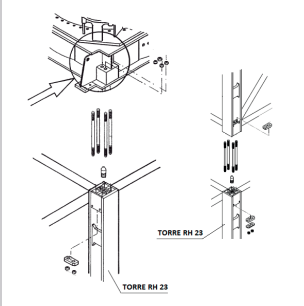

TOWER TYPE HR 23

The well known H beam mast sections with vertical bolts connection will allow greater free standing heights. Available in three versions: base reinforced (HR 23-30), heavy duty (HR 23-26) and std duty type (HR 23-22).

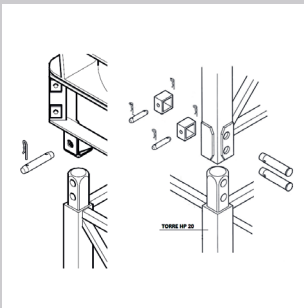

TOWER TYPE HP 20

The famous boxed beams -twin pins connections. Safety and performances trough pins.

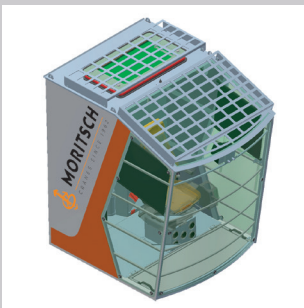

CABIN

New design CAB , wider, longer, with improved visibility. Grammer seat and gessman joy-stick for driver cofort and ABB controls for maximum safety. USB door, air con, easy cleaning of windows, 10" or 7" screen included.

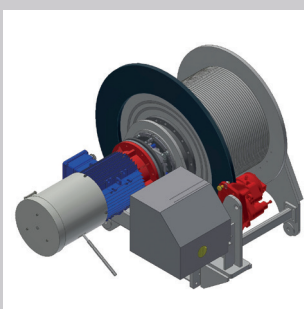
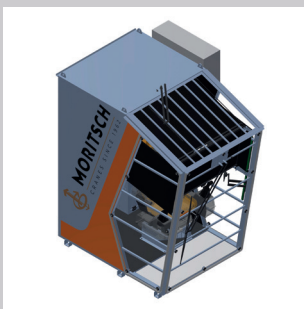

WINCHES

New generation of high power winches , from 45 to 67 kW. New braking system, new reduction gear to grant highest performances ever seen on a low top.



RTT 330







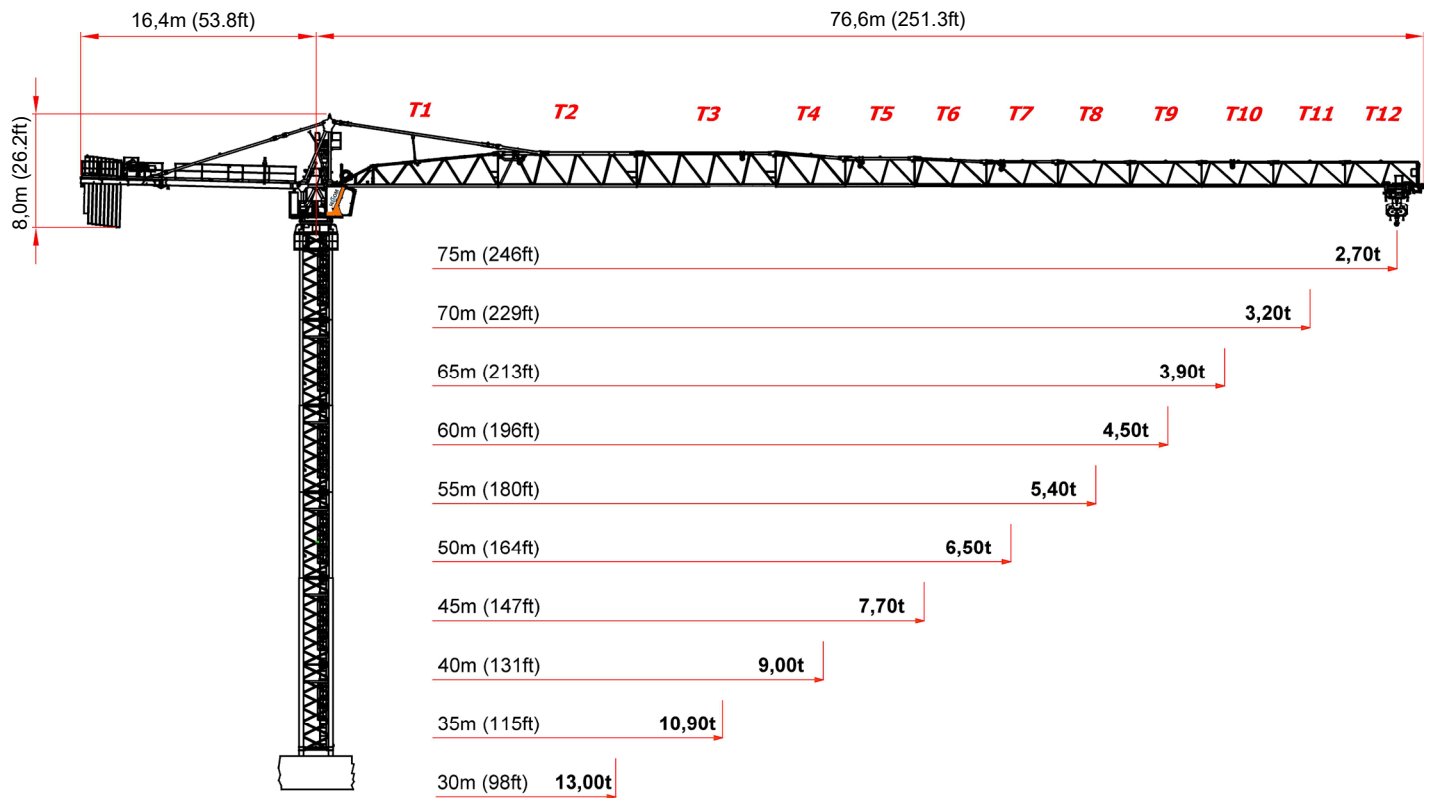























16 HR23/HP20 II/IV / FALLS

TECHNICAL DATA SHEET

CE EN 14439: 2009
FEM 1.001 - A3



RTT 330 - 16

| | (t) | m | 15 | 20 | 25 | 30 | 35 | 40 | 45 | 50 | 55 | 60 | 65 | 70 | 75 |
|---|-------|-------|-------|-------|-------|-------|-------|------|------|------|------|------|------|------|------|
|  | 8,00 | 33,45 | 8,00 | 8,00 | 8,00 | 8,00 | 7,58 | 6,43 | 5,54 | 4,83 | 4,25 | 3,77 | 3,36 | 3,00 | 2,70 |
|  * | 8,00 | 32,46 | 8,00 | 8,00 | 8,00 | 8,00 | 7,28 | 6,14 | 5,25 | 4,54 | 3,95 | 3,47 | 3,06 | 2,71 | 2,40 |
|  | 16,00 | 18,71 | 16,00 | 14,83 | 11,44 | 9,18 | 7,57 | 6,36 | 5,41 | 4,66 | 4,04 | 3,53 | 3,10 | 2,72 | 2,40 |
|  | 8,00 | 34,54 | 8,00 | 8,00 | 8,00 | 8,00 | 7,88 | 6,71 | 5,80 | 5,07 | 4,48 | 3,98 | 3,56 | 3,20 | |
|  * | 8,00 | 33,50 | 8,00 | 8,00 | 8,00 | 8,00 | 7,58 | 6,41 | 5,50 | 4,77 | 4,18 | 3,68 | 3,26 | 2,90 | |
|  | 16,00 | 19,16 | 16,00 | 15,25 | 11,79 | 9,48 | 7,84 | 6,60 | 5,64 | 4,88 | 4,25 | 3,72 | 3,28 | 2,90 | |
|  | 8,00 | 36,61 | 8,00 | 8,00 | 8,00 | 8,00 | 8,00 | 7,20 | 6,25 | 5,49 | 4,86 | 4,34 | 3,90 | | |
|  * | 8,00 | 35,49 | 8,00 | 8,00 | 8,00 | 8,00 | 8,00 | 6,91 | 5,95 | 5,19 | 4,56 | 4,04 | 3,60 | | |
|  | 16,00 | 20,12 | 16,00 | 16,00 | 12,50 | 10,09 | 8,37 | 7,08 | 6,07 | 5,27 | 4,61 | 4,06 | 3,60 | | |
|  | 8,00 | 35,35 | 8,00 | 8,00 | 8,00 | 8,00 | 8,00 | 7,01 | 6,17 | 5,50 | 4,96 | 4,50 | | | |
|  * | 8,00 | 36,88 | 8,00 | 8,00 | 8,00 | 8,00 | 8,00 | 7,25 | 6,27 | 5,48 | 4,84 | 4,30 | | | |
|  | 16,00 | 20,74 | 16,00 | 16,00 | 12,95 | 10,48 | 8,71 | 7,39 | 6,36 | 5,54 | 4,86 | 4,30 | | | |
|  | 8,00 | 39,64 | 8,00 | 8,00 | 8,00 | 8,00 | 8,00 | 7,92 | 6,89 | 6,07 | 5,40 | | | | |
|  * | 8,00 | 38,42 | 8,00 | 8,00 | 8,00 | 8,00 | 8,00 | 7,62 | 6,59 | 5,77 | 5,10 | | | | |
|  | 16,00 | 21,53 | 16,00 | 16,00 | 13,51 | 10,94 | 9,11 | 7,73 | 6,66 | 5,80 | 5,10 | | | | |
|  | 8,00 | 41,96 | 8,00 | 8,00 | 8,00 | 8,00 | 8,00 | 8,00 | 7,37 | 6,50 | | | | | |
|  * | 8,00 | 40,66 | 8,00 | 8,00 | 8,00 | 8,00 | 8,00 | 8,00 | 7,07 | 6,20 | | | | | |
|  | 16,00 | 22,70 | 16,00 | 16,00 | 14,35 | 11,63 | 9,69 | 8,24 | 7,11 | 6,20 | | | | | |
|  | 8,00 | 43,56 | 8,00 | 8,00 | 8,00 | 8,00 | 8,00 | 8,00 | 7,70 | | | | | | |
|  * | 8,00 | 42,21 | 8,00 | 8,00 | 8,00 | 8,00 | 8,00 | 8,00 | 7,40 | | | | | | |
|  | 16,00 | 23,49 | 16,00 | 16,00 | 14,91 | 12,10 | 10,08 | 8,57 | 7,40 | | | | | | |
|  | 8,00 | 40,00 | 8,00 | 8,00 | 8,00 | 8,00 | 8,00 | 8,00 | 8,00 | | | | | | |
|  * | 8,00 | 40,00 | 8,00 | 8,00 | 8,00 | 8,00 | 8,00 | 8,00 | 8,00 | | | | | | |
|  | 16,00 | 24,49 | 16,00 | 16,00 | 15,63 | 12,68 | 10,58 | 9,00 | | | | | | | |
|  | 8,00 | 35,00 | 8,00 | 8,00 | 8,00 | 8,00 | 8,00 | 8,00 | | | | | | | |
|  * | 8,00 | 35,00 | 8,00 | 8,00 | 8,00 | 8,00 | 8,00 | 8,00 | | | | | | | |
|  | 16,00 | 25,15 | 16,00 | 16,00 | 16,00 | 13,07 | 10,90 | | | | | | | | |
|  | 8,00 | 30,00 | 8,00 | 8,00 | 8,00 | 8,00 | 8,00 | | | | | | | | |
|  * | 8,00 | 30,00 | 8,00 | 8,00 | 8,00 | 8,00 | 8,00 | | | | | | | | |
|  | 16,00 | 25,06 | 16,00 | 16,00 | 16,00 | 13,00 | | | | | | | | | |

 * II falls with double hoist block



































RTT 330 - 16

| | (lb) | ft | 49 | 66 | 82 | 98 | 115 | 131 | 148 | 164 | 180 | 197 | 213 | 230 | 246 |
|---|-------|--------|-------|-------|-------|-------|-------|-------|-------|-------|-------|-------|-------|-------|------|
| | 17632 | 109,72 | 17632 | 17632 | 17632 | 17632 | 16699 | 14180 | 12220 | 10653 | 9371 | 8302 | 7398 | 6623 | 5951 |
| * | 17632 | 106,47 | 17632 | 17632 | 17632 | 17632 | 16053 | 13530 | 11568 | 9998 | 8714 | 7644 | 6738 | 5962 | 5290 |
| | 35264 | 61,36 | 35264 | 32685 | 25214 | 20233 | 16675 | 14006 | 11931 | 10271 | 8912 | 7780 | 6822 | 6001 | 5290 |
| | 17632 | 113,30 | 17632 | 17632 | 17632 | 17632 | 17359 | 14782 | 12778 | 11175 | 9864 | 8770 | 7846 | 7053 | |
| * | 17632 | 109,87 | 17632 | 17632 | 17632 | 17632 | 16706 | 14128 | 12122 | 10517 | 9205 | 8111 | 7185 | 6392 | |
| | 35264 | 62,85 | 35264 | 33600 | 25982 | 20903 | 17275 | 14554 | 12438 | 10745 | 9360 | 8205 | 7229 | 6392 | |
| | 17632 | 120,08 | 17632 | 17632 | 17632 | 17632 | 17632 | 15878 | 13775 | 12091 | 10714 | 9567 | 8596 | 7934 | |
| * | 17632 | 116,39 | 17632 | 17632 | 17632 | 17632 | 17632 | 15221 | 13116 | 11432 | 10054 | 8906 | 7934 | 7934 | |
| | 35264 | 66,00 | 35264 | 35264 | 27541 | 22231 | 18438 | 15593 | 13381 | 11611 | 10162 | 8956 | 7934 | 7934 | |
| | 17632 | 115,95 | 17632 | 17632 | 17632 | 17632 | 17632 | 15450 | 13606 | 12131 | 10924 | 9918 | 9477 | 9477 | |
| * | 17632 | 120,95 | 17632 | 17632 | 17632 | 17632 | 17632 | 15979 | 13812 | 12078 | 10659 | 9477 | 9477 | 9477 | |
| | 35264 | 68,02 | 35264 | 35264 | 28546 | 23098 | 19206 | 16288 | 14017 | 12201 | 10715 | 9477 | 9477 | 9477 | |
| | 17632 | 130,02 | 17632 | 17632 | 17632 | 17632 | 17632 | 17447 | 15188 | 13380 | 11902 | 11240 | 11240 | 11240 | |
| * | 17632 | 126,02 | 17632 | 17632 | 17632 | 17632 | 17632 | 16794 | 14532 | 12721 | 11240 | 11240 | 11240 | 11240 | |
| | 35264 | 70,61 | 35264 | 35264 | 29780 | 24115 | 20069 | 17034 | 14674 | 12785 | 11240 | 11240 | 11240 | 11240 | |
| | 17632 | 137,63 | 17632 | 17632 | 17632 | 17632 | 17632 | 17632 | 16243 | 14326 | 14326 | 14326 | 14326 | 14326 | |
| * | 17632 | 133,38 | 17632 | 17632 | 17632 | 17632 | 17632 | 17632 | 15585 | 13665 | 13665 | 13665 | 13665 | 13665 | |
| | 35264 | 74,46 | 35264 | 35264 | 31627 | 25640 | 21363 | 18155 | 15661 | 13665 | 13665 | 13665 | 13665 | 13665 | |
| | 17632 | 142,89 | 17632 | 17632 | 17632 | 17632 | 17632 | 17632 | 16971 | 16971 | 16971 | 16971 | 16971 | 16971 | |
| * | 17632 | 138,45 | 17632 | 17632 | 17632 | 17632 | 17632 | 17632 | 16310 | 16310 | 16310 | 16310 | 16310 | 16310 | |
| | 35264 | 77,04 | 35264 | 35264 | 32866 | 26657 | 22223 | 18897 | 16310 | 16310 | 16310 | 16310 | 16310 | 16310 | |
| | 17632 | 131,20 | 17632 | 17632 | 17632 | 17632 | 17632 | 17632 | 17632 | 17632 | 17632 | 17632 | 17632 | 17632 | |
| * | 17632 | 131,20 | 17632 | 17632 | 17632 | 17632 | 17632 | 17632 | 17632 | 17632 | 17632 | 17632 | 17632 | 17632 | |
| | 35264 | 80,32 | 35264 | 35264 | 34449 | 27954 | 23315 | 19836 | 19836 | 19836 | 19836 | 19836 | 19836 | 19836 | |
| | 17632 | 114,80 | 17632 | 17632 | 17632 | 17632 | 17632 | 17632 | 17632 | 17632 | 17632 | 17632 | 17632 | 17632 | |
| * | 17632 | 114,80 | 17632 | 17632 | 17632 | 17632 | 17632 | 17632 | 17632 | 17632 | 17632 | 17632 | 17632 | 17632 | |
| | 35264 | 82,49 | 35264 | 35264 | 35264 | 28806 | 24024 | 24024 | 24024 | 24024 | 24024 | 24024 | 24024 | 24024 | |
| | 17632 | 98,40 | 17632 | 17632 | 17632 | 17632 | 17632 | 17632 | 17632 | 17632 | 17632 | 17632 | 17632 | 17632 | |
| * | 17632 | 98,40 | 17632 | 17632 | 17632 | 17632 | 17632 | 17632 | 17632 | 17632 | 17632 | 17632 | 17632 | 17632 | |
| | 35264 | 82,20 | 35264 | 35264 | 35264 | 28652 | 28652 | 28652 | 28652 | 28652 | 28652 | 28652 | 28652 | 28652 | |

* II falls with double hoist block

RTT 330 - 16 M-LIFT

| | (t) | m | 15 | 20 | 25 | 30 | 35 | 40 | 45 | 50 | 55 | 60 | 65 | 70 | 75 |
|---|-------|-------|-------|-------|-------|-------|-------|------|------|------|------|------|------|------|------|
|  | 8,00 | 35,57 | 8,00 | 8,00 | 8,00 | 8,00 | 8,00 | 6,94 | 5,99 | 5,24 | 4,62 | 4,10 | 3,67 | 3,29 | 2,97 |
|  * | 8,00 | 34,28 | 8,00 | 8,00 | 8,00 | 8,00 | 7,80 | 6,59 | 5,65 | 4,90 | 4,28 | 3,77 | 3,33 | 2,96 | 2,64 |
|  | 16,00 | 19,70 | 16,00 | 15,73 | 12,16 | 9,78 | 8,08 | 6,81 | 5,81 | 5,02 | 4,37 | 3,83 | 3,37 | 2,98 | 2,64 |
|  | 8,00 | 36,91 | 8,00 | 8,00 | 8,00 | 8,00 | 8,00 | 7,27 | 6,30 | 5,52 | 4,88 | 4,35 | 3,90 | 3,52 | |
|  * | 8,00 | 35,57 | 8,00 | 8,00 | 8,00 | 8,00 | 8,00 | 6,92 | 5,95 | 5,18 | 4,55 | 4,02 | 3,57 | 3,19 | |
|  | 16,00 | 20,29 | 16,00 | 16,00 | 12,60 | 10,16 | 8,42 | 7,11 | 6,09 | 5,28 | 4,62 | 4,06 | 3,59 | 3,19 | |
|  | 8,00 | 39,31 | 8,00 | 8,00 | 8,00 | 8,00 | 8,00 | 7,84 | 6,81 | 5,99 | 5,32 | 4,76 | 4,29 | | |
|  * | 8,00 | 37,90 | 8,00 | 8,00 | 8,00 | 8,00 | 8,00 | 7,49 | 6,47 | 5,66 | 4,99 | 4,43 | 3,96 | | |
|  | 16,00 | 21,43 | 16,00 | 16,00 | 13,43 | 10,87 | 9,03 | 7,66 | 6,59 | 5,74 | 5,04 | 4,45 | 3,96 | | |
|  | 8,00 | 38,52 | 8,00 | 8,00 | 8,00 | 8,00 | 8,00 | 7,69 | 6,77 | 6,04 | 5,45 | 4,95 | | | |
|  * | 8,00 | 39,56 | 8,00 | 8,00 | 8,00 | 8,00 | 8,00 | 7,90 | 6,84 | 6,00 | 5,31 | 4,73 | | | |
|  | 16,00 | 22,18 | 16,00 | 16,00 | 13,98 | 11,34 | 9,45 | 8,04 | 6,93 | 6,05 | 5,33 | 4,73 | | | |
|  | 8,00 | 42,83 | 8,00 | 8,00 | 8,00 | 8,00 | 8,00 | 8,00 | 7,55 | 6,67 | 5,94 | | | | |
|  * | 8,00 | 41,34 | 8,00 | 8,00 | 8,00 | 8,00 | 8,00 | 8,00 | 7,22 | 6,33 | 5,61 | | | | |
|  | 16,00 | 23,09 | 16,00 | 16,00 | 14,63 | 11,88 | 9,91 | 8,43 | 7,28 | 6,36 | 5,61 | | | | |
|  | 8,00 | 45,44 | 8,00 | 8,00 | 8,00 | 8,00 | 8,00 | 8,00 | 8,00 | 7,15 | | | | | |
|  * | 8,00 | 43,88 | 8,00 | 8,00 | 8,00 | 8,00 | 8,00 | 8,00 | 8,00 | 7,76 | 6,82 | | | | |
|  | 16,00 | 24,43 | 16,00 | 16,00 | 15,59 | 12,67 | 10,58 | 9,01 | 7,79 | 6,82 | | | | | |
|  | 8,00 | 45,00 | 8,00 | 8,00 | 8,00 | 8,00 | 8,00 | 8,00 | 8,00 | 8,00 | | | | | |
|  * | 8,00 | 45,00 | 8,00 | 8,00 | 8,00 | 8,00 | 8,00 | 8,00 | 8,00 | 8,00 | | | | | |
|  | 16,00 | 25,34 | 16,00 | 16,00 | 16,00 | 13,21 | 11,03 | 9,41 | 8,14 | | | | | | |
|  | 8,00 | 40,00 | 8,00 | 8,00 | 8,00 | 8,00 | 8,00 | 8,00 | 8,00 | | | | | | |
|  * | 8,00 | 40,00 | 8,00 | 8,00 | 8,00 | 8,00 | 8,00 | 8,00 | 8,00 | | | | | | |
|  | 16,00 | 26,48 | 16,00 | 16,00 | 16,00 | 13,88 | 11,61 | 9,90 | | | | | | | |
|  | 8,00 | 35,00 | 8,00 | 8,00 | 8,00 | 8,00 | 8,00 | 8,00 | | | | | | | |
|  * | 8,00 | 35,00 | 8,00 | 8,00 | 8,00 | 8,00 | 8,00 | 8,00 | | | | | | | |
|  | 16,00 | 27,25 | 16,00 | 16,00 | 16,00 | 14,34 | 11,99 | | | | | | | | |
|  | 8,00 | 30,00 | 8,00 | 8,00 | 8,00 | 8,00 | 8,00 | | | | | | | | |
|  * | 8,00 | 30,00 | 8,00 | 8,00 | 8,00 | 8,00 | 8,00 | | | | | | | | |
|  | 16,00 | 27,20 | 16,00 | 16,00 | 16,00 | 14,30 | | | | | | | | | |

 * II falls with double hoist block



RTT 330 - 16 HR23/HP20



RTT 330 - 16 M-LIFT

| | (lb) | ft | 49 | 66 | 82 | 98 | 115 | 131 | 148 | 164 | 180 | 197 | 213 | 230 | 246 |
|---|--------------|---------------|-------|-------|-------|--------------|--------------|--------------|--------------|--------------|--------------|--------------|-------------|-------------|-------------|
| | 17632 | 116,66 | 17632 | 17632 | 17632 | 17632 | 17632 | 15295 | 13212 | 11546 | 10182 | 9046 | 8084 | 7260 | 6546 |
| * | 17632 | 112,45 | 17632 | 17632 | 17632 | 17632 | 17186 | 14522 | 12450 | 10792 | 9436 | 8305 | 7349 | 6529 | 5819 |
| | 35264 | 64,62 | 35264 | 34669 | 26801 | 21555 | 17808 | 14998 | 12813 | 11064 | 9633 | 8441 | 7433 | 6568 | 5819 |
| | 17632 | 121,05 | 17632 | 17632 | 17632 | 17632 | 17632 | 16016 | 13875 | 12163 | 10761 | 9593 | 8605 | 7758 | |
| * | 17632 | 116,68 | 17632 | 17632 | 17632 | 17632 | 17632 | 15246 | 13116 | 11412 | 10018 | 8856 | 7873 | 7031 | |
| | 35264 | 66,55 | 35264 | 35264 | 27771 | 22394 | 18553 | 15673 | 13432 | 11640 | 10173 | 8951 | 7917 | 7031 | |
| | 17632 | 128,94 | 17632 | 17632 | 17632 | 17632 | 17632 | 17275 | 15016 | 13209 | 11730 | 10498 | 9455 | | |
| * | 17632 | 124,31 | 17632 | 17632 | 17632 | 17632 | 17632 | 16511 | 14262 | 12464 | 10992 | 9766 | 8728 | | |
| | 35264 | 70,28 | 35264 | 35264 | 29604 | 23950 | 19912 | 16883 | 14527 | 12642 | 11100 | 9815 | 8728 | | |
| | 17632 | 126,35 | 17632 | 17632 | 17632 | 17632 | 17632 | 16938 | 14928 | 13321 | 12006 | 10910 | | | |
| * | 17632 | 129,77 | 17632 | 17632 | 17632 | 17632 | 17632 | 17401 | 15075 | 13215 | 11693 | 10425 | | | |
| | 35264 | 72,75 | 35264 | 35264 | 30821 | 24993 | 20831 | 17709 | 15281 | 13339 | 11749 | 10425 | | | |
| | 17632 | 140,48 | 17632 | 17632 | 17632 | 17632 | 17632 | 17632 | 16643 | 14690 | 13092 | | | | |
| * | 17632 | 135,58 | 17632 | 17632 | 17632 | 17632 | 17632 | 17632 | 15906 | 13958 | 12364 | | | | |
| | 35264 | 75,75 | 35264 | 35264 | 32253 | 26176 | 21835 | 18580 | 16048 | 14022 | 12364 | | | | |
| | 17632 | 149,06 | 17632 | 17632 | 17632 | 17632 | 17632 | 17632 | 17632 | 15759 | | | | | |
| * | 17632 | 143,93 | 17632 | 17632 | 17632 | 17632 | 17632 | 17632 | 17103 | 15031 | | | | | |
| | 35264 | 80,13 | 35264 | 35264 | 34360 | 27917 | 23315 | 19864 | 17179 | 15031 | | | | | |
| | 17632 | 147,60 | 17632 | 17632 | 17632 | 17632 | 17632 | 17632 | 17632 | | | | | | |
| * | 17632 | 147,60 | 17632 | 17632 | 17632 | 17632 | 17632 | 17632 | 17632 | | | | | | |
| | 35264 | 83,11 | 35264 | 35264 | 35264 | 29104 | 24320 | 20731 | 17941 | | | | | | |
| | 17632 | 131,20 | 17632 | 17632 | 17632 | 17632 | 17632 | 17632 | | | | | | | |
| * | 17632 | 131,20 | 17632 | 17632 | 17632 | 17632 | 17632 | 17632 | | | | | | | |
| | 35264 | 86,86 | 35264 | 35264 | 35264 | 30599 | 25582 | 21820 | | | | | | | |
| | 17632 | 114,80 | 17632 | 17632 | 17632 | 17632 | 17632 | | | | | | | | |
| * | 17632 | 114,80 | 17632 | 17632 | 17632 | 17632 | 17632 | | | | | | | | |
| | 35264 | 89,39 | 35264 | 35264 | 35264 | 31609 | 26426 | | | | | | | | |
| | 17632 | 98,40 | 17632 | 17632 | 17632 | 17632 | | | | | | | | | |
| * | 17632 | 98,40 | 17632 | 17632 | 17632 | 17632 | | | | | | | | | |
| | 35264 | 89,22 | 35264 | 35264 | 35264 | 31517 | | | | | | | | | |



* II falls with double hoist block

HR23

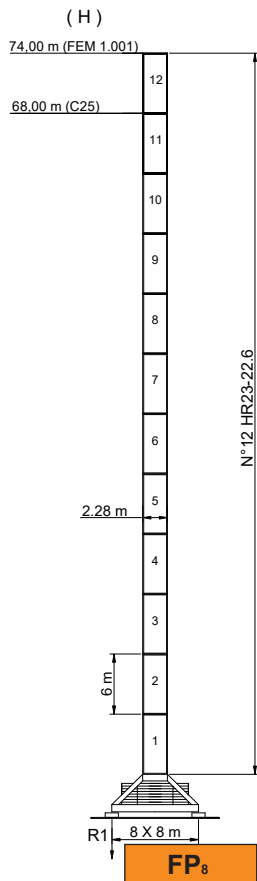
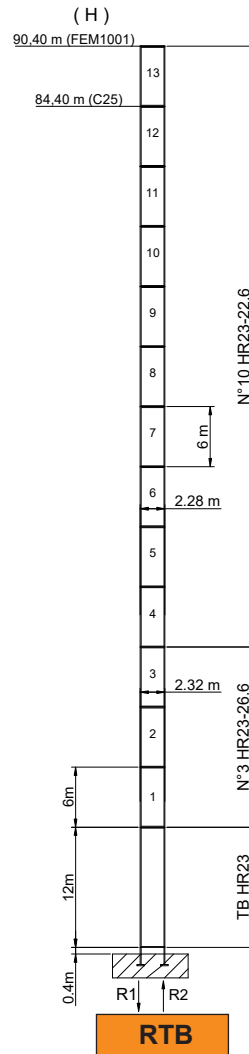
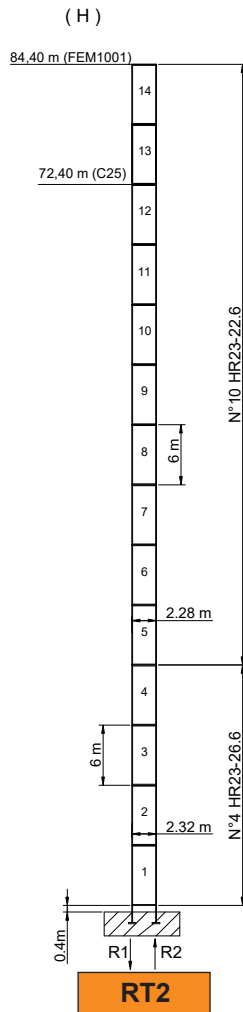
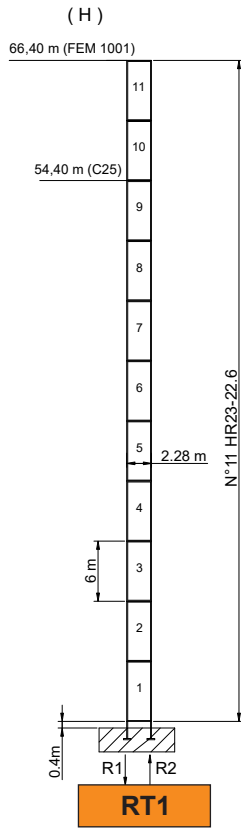

* Please ask tech. Dept.
(C25) , (D25) FEM 1.004 out of service wind condition
Different height and tower combinations are - please consult us

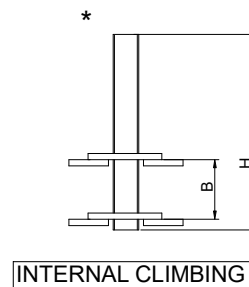
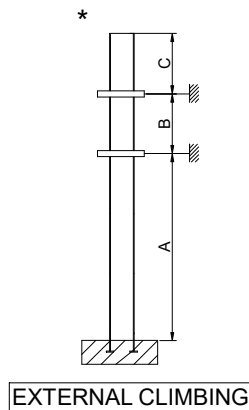

HP20



RTT 330 - 16 HR23/HP20

10

V.4 - 02/20 - Subject to change without notice

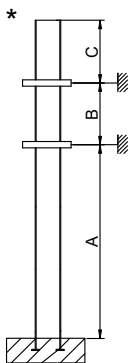
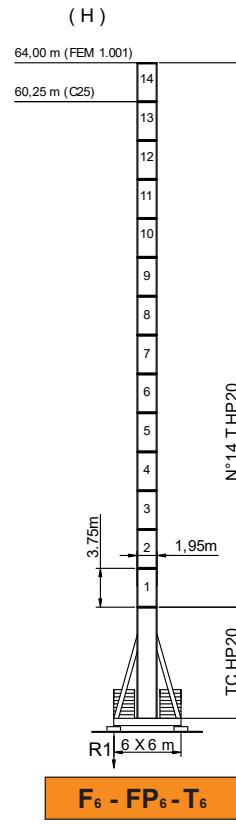
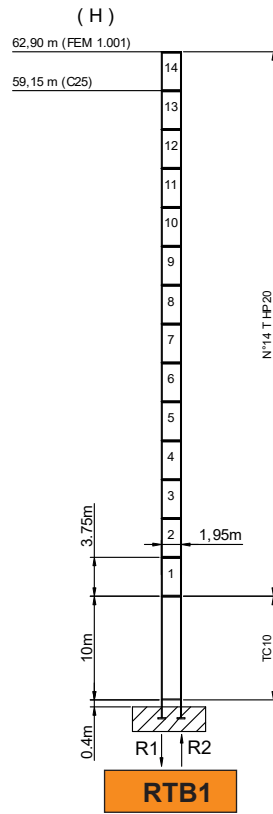
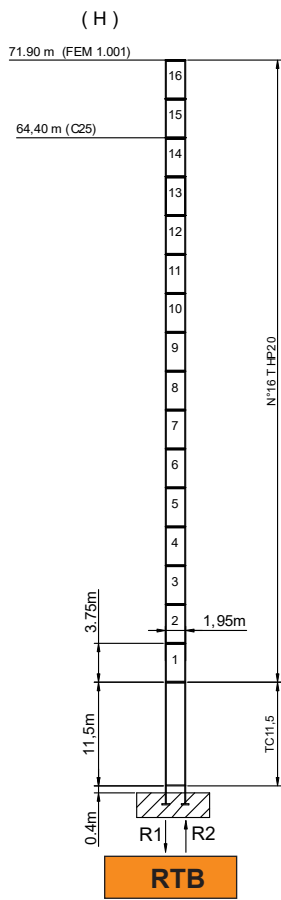

EXTERNAL CLIMBING

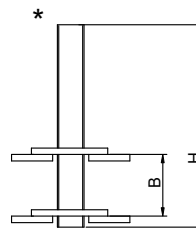

INTERNAL CLIMBING

* Please ask tech. Dept.

(C25) FEM 1.004 out of service wind conditions

Different height and tower combinations are available - please consult us

45 HVF 80

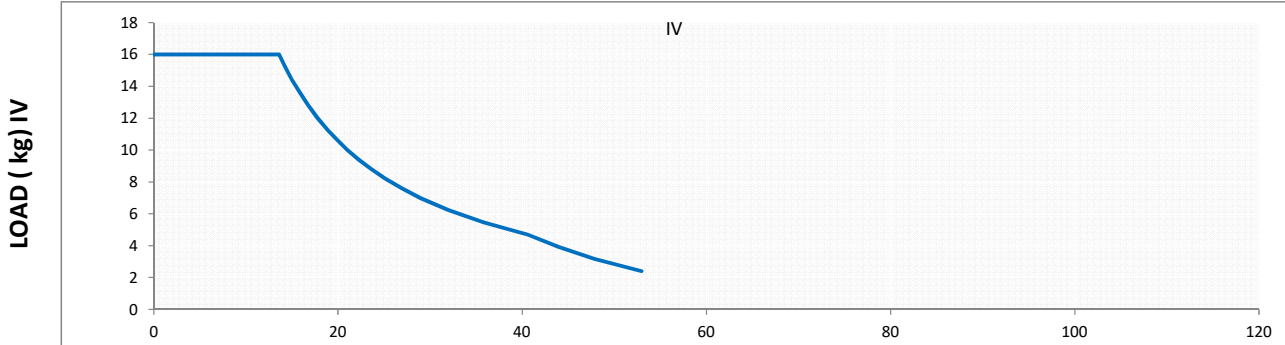
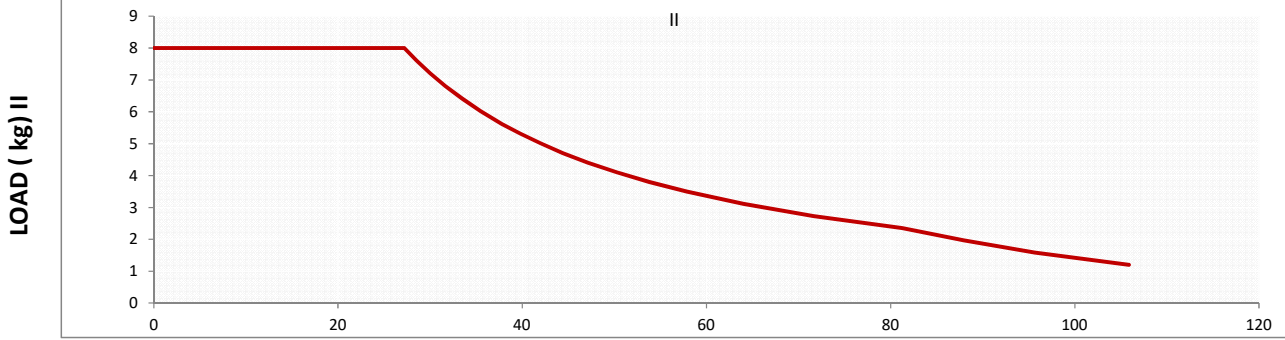

HOISTING

| | | | t | m/min | | | kW | | |
|--|-----------|--|-----|-------|---|-----|----|-------|----|
| | 45 HVF 80 | | 8 | 0 | → | 27 | 45 | 700 m | |
| | | | 6 | 0 | → | 36 | | | |
| | | | 2,7 | 0 | → | 72 | | | |
| | | | 1,2 | 0 | → | 106 | | | |
| | | | 16 | 0 | → | 13 | | | |
| | | | | 12 | 0 | → | | | 18 |
| | | | | 5 | 0 | → | | | 40 |
| | | | | 3,5 | 0 | → | | | 46 |

- Hoisting Winch 45 kW Max rope on drum: 700 m

- Trolley Winch 7.5 kW 0 - 90 m/min

- Slewing 3 x 11 kW

- max power T7.5kW S3x11kW H45kW : 120 kVA



RTT 330 - 16 HR23/HP20



67 HVF 80

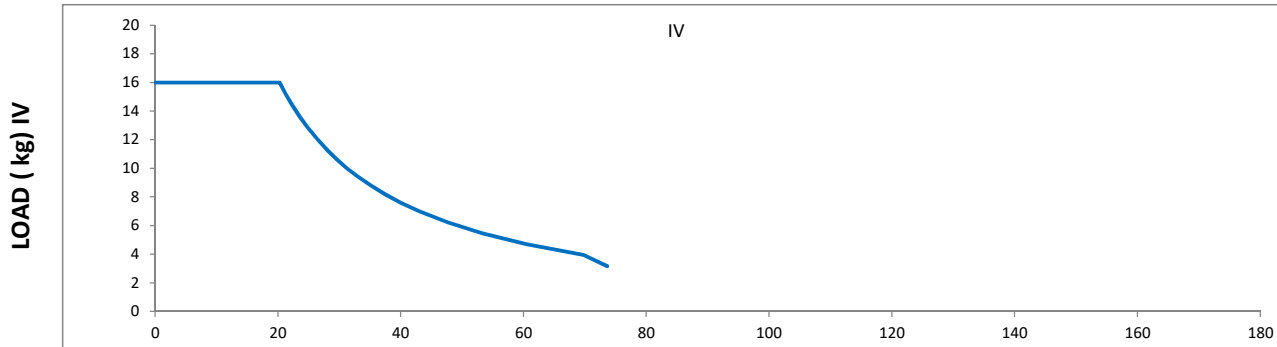
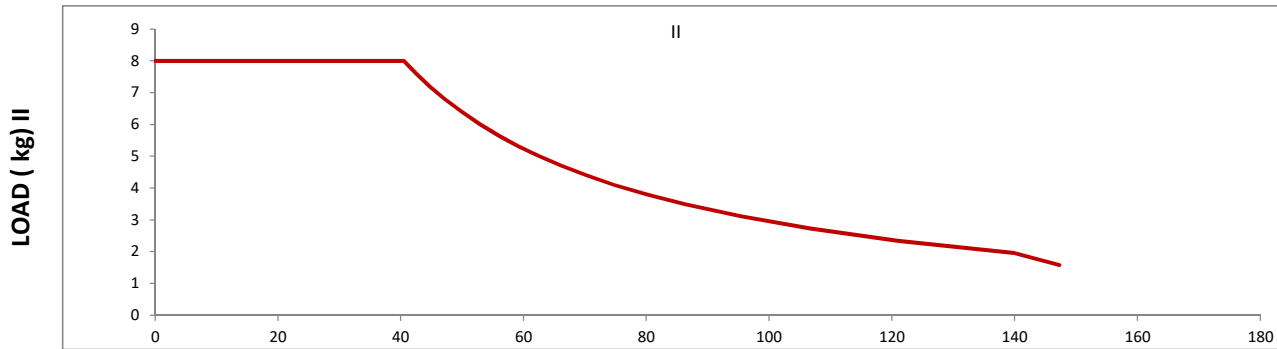

HOISTING

| | | | | t | m/min | | kW | |
|--|-----------|--|--|-----|-------|-------|----|-------|
| | 67 HVF 80 | | | 8 | 0 | → 40 | 67 | 700 m |
| | | | | 6 | 0 | → 53 | | |
| | | | | 3 | 0 | → 95 | | |
| | | | | 1,6 | 0 | → 147 | | |
| | | | | 16 | 0 | → 20 | | |
| | | | | 12 | 0 | → 26 | | |
| | | | | 7 | 0 | → 43 | | |
| | | | | 3,8 | 0 | → 69 | | |

Hoisting Winch 67 kW Max rope on drum: 700 m

Trolley Winch 7.5 kW 0 - 90 m/min

Slewing 3 x 11 kW

max power T7.5kW S3x11kW H67kW : 150 kVA



MORITSCH

CRANES SINCE 1962

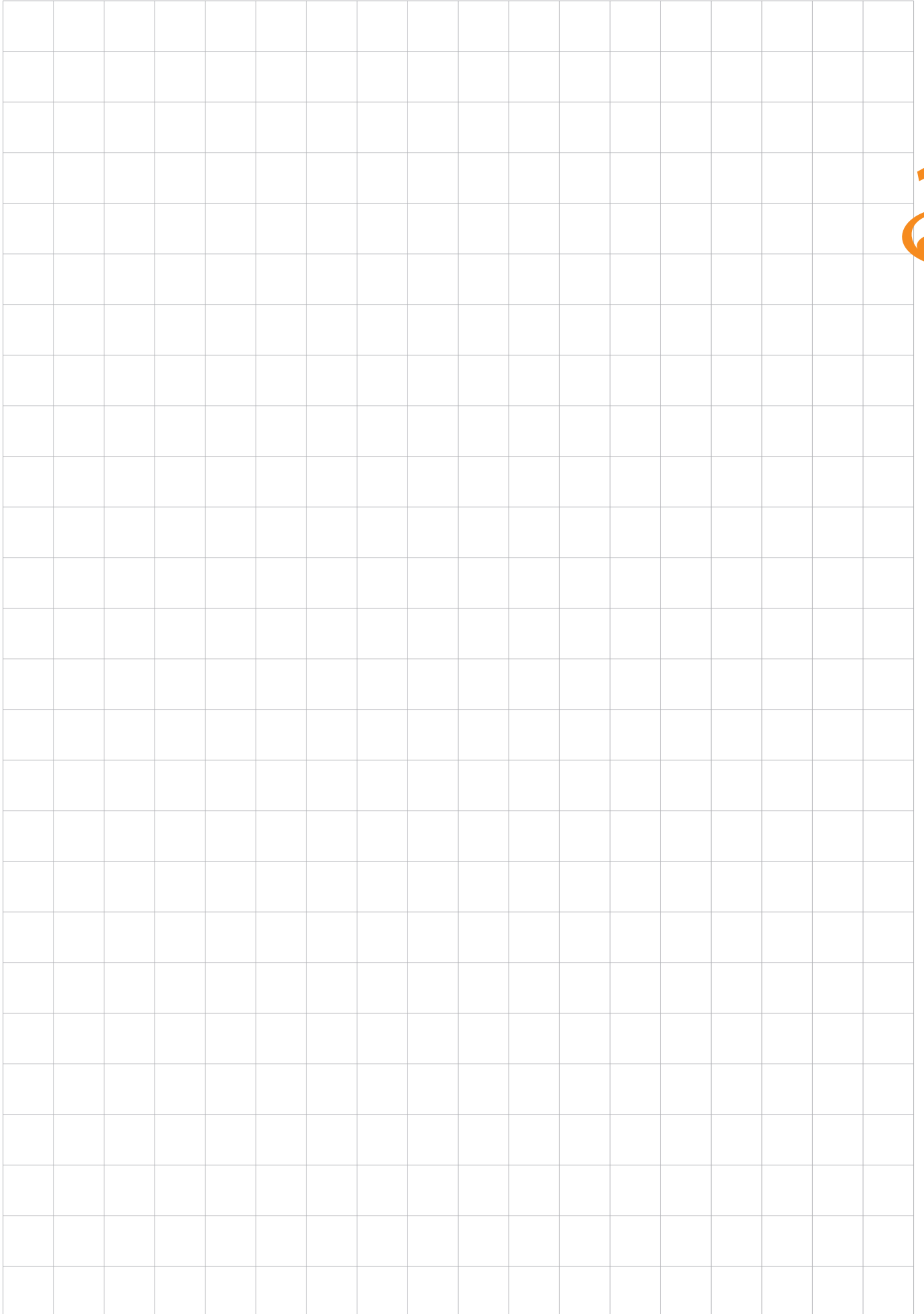

RTT 330 - 16 HR23/HP20



MORITSCH

CRANES SINCE 1962

Moritsch Cranes S.r.l.

via Ramentera 52
32035 Santa Giustina | BL | Italy

T. +39 0437 1840396

info@moritsch.it

www.moritsch.it

